

medi tech  
systems limited

Supporting every breath

# Airway Management

Visit us: [www.meditechsystems.co.uk](http://www.meditechsystems.co.uk)

📘 facebook: meditechsystemslimited 🐦 twitter: @MeditechLtd

## Meditech Systems Limited supply superior, affordable, quality airway accessories and devices.

Meditech is a well established British based manufacturer with a strong commitment to product innovation. This innovation is borne out of our close customer contact and has proven to be the catalyst for our growth.

We supply superior, affordable, quality accessories in the areas of airway management and electrosurgery. Our range of products offer excellent value for money and are designed to meet the high standards of the constantly changing health market.

We now offer TIMETAG™ on all of our breathing systems or any other relevant product (7 day use). Simply activated with finger press button. A red indicator highlights the daily progress, with a unique reference number on the timer which is linked to the product batch number in use. Other time control periods available. This is a great time management tool helping to reduce manual date recording, plus a great visual reference.

The Silver Sentinel range of products contain a silver ion additive within the tubing that rapidly disrupts the normal enzyme activities of certain bacteria resulting in rapidly combating Hospital Acquired Infections (HAI) such as MRSA and other micro-organisms. All Silver Sentinel systems are identified with a distinct purple tinted tubing. Silver Sentinel is available on all of our systems except smoothbore.

**Our aim at Meditech Systems Limited is to grow through partnership with our customers providing the quality, value and service required in today's ever changing health care industry.**

FDA registration No.10048739 Australia TGA listed

Safety information All Meditech products are designed and manufactured to meet the requirements of relevant BS, ISO and EN standards. Compliance with ISO 9001: 2008 ISO 13485 and EU Directive 93/42/EEC Annex II, Annex V of the Medical Devices Directive allows CE marking of all of our products. This enables products to be traded throughout Europe and the world without restriction.





# CONTENTS

## Intubation

Laryngeal masks airways and SAFE-T-BAG®.....	4
Laryngoscope blades & handles.....	6

## Difficult intubation

RAPIDO2® and bougies .....	7
----------------------------	---

## Patient end connection

MEDI FLEX™ and X-Tendible™ Catheter mounts.....	8
Connectors and accessories.....	9

## Filters

MEDI STAT™ filters.....	10
MEDI PLEAT™ and MEDI FOAM™ filters.....	11

## Anaesthesia

Air cushion, silicone and ECO masks.....	12
MaplesonD and MaplesonC systems.....	13
MaplesonA and Jackson Rees systems.....	14
MaplesonF systems.....	15
Parallel, Smoothbore, X-Tendible™ systems.....	16
Swivel and MEDI LIMB™ systems .....	17
GE Healthcare and Carestation.....	18

## Critical care

Water trap, Paediatric and X-Tendible™ systems.....	19
Smoothbore and ported Y watertrap systems .....	20
Single heated and dual heated water traps.....	21
Volume ventilator, CPAP masks and systems.....	22
Entonox systems.....	23

## Oxygen and aerosol therapy

Interchangeable systems .....	24
Venturi kits, fittings and jets.....	25
Cannulae and tubing .....	26
Oxygen and aerosol masks.....	27
CO2 Range .....	28
Nebuliser kits and accessories.....	29
Resuscitation kits and Nasopharyngeal.....	30
Guedels and Bermans .....	31





## Supraglottic (laryngeal) mask airways



Standard silicone: 22LMA30



Reinforced silicone: 22LMRE50



Reusable: 22LMA50RE

ID: inside diameter OD: Outside Diameter.

CODE	WEIGHT	SIZE	ID	OD	ET TUBE SIZE	VALVE	UNITS
------	--------	------	----	----	--------------	-------	-------

### Standard silicone Supraglottic mask

Ideal for use in both anaesthesia and emergency medicine.

22LMA10	②	infants < 5kg	size 1	●	5	8	3.5	<4ml	5
22LMA15	②	infants 5-10kg	size 1.5	●	6	10	4	<7ml	5
22LMA20	②	children 10-20kg	size 2	○	7	11	4.5	<10ml	5
22LMA25	②	children 20-30kg	size 2.5	●	8.5	13	5	<14ml	5
22LMA30	②	children 30-50kg	size 3	●	10	15	6 cuffed	<20ml	5
22LMA40	②	adults 50-70kg	size 4	●	10	15	6 cuffed	<30ml	5
22LMA50	②	adults 70-100kg	size 5	●	11	16.5	7 cuffed	<40ml	5

### Reinforced silicone Supraglottic mask

Ideal solution for shared airway procedures.

22LMRE10	②	infants < 5kg	size 1	●	5	8	3.5	<4ml	5
22LMRE15	②	infants 5-10kg	size 1.5	●	6	10	4	<7ml	5
22LMRE20	②	children 10-20kg	size 2	○	7	11	4.5	<10ml	5
22LMRE25	②	children 20-30kg	size 2.5	●	8.5	13	5	<14ml	5
22LMRE30	②	children 30-50kg	size 3	●	10	15	6 cuffed	<20ml	5
22LMRE40	②	adults 50-70kg	size 4	●	10	15	6 cuffed	<30ml	5
22LMRE50	②	adults 70-100kg	size 5	●	11	16.5	7 cuffed	<40ml	5

### PVC Supraglottic mask

22LMSP10	②	infants < 5kg	size 1	●	5.2	8.2	3.5	<4ml	5
22LMSP15	②	infants 5-10kg	size 1.5	●	6.5	10	4	<7ml	5
22LMSP20	②	children 10-20kg	size 2	○	7.5	11.5	4.5	<10ml	5
22LMSP25	②	children 20-30kg	size 2.5	●	8	13.5	5	<14ml	5
22LMSP30	②	children 30-50kg	size 3	●	10.2	15	6 cuffed	<20ml	5
22LMSP40	②	adults 50-70kg	size 4	●	10.2	15	6 cuffed	<30ml	5
22LMSP50	②	adults 70-100kg	size 5	●	11	16	7 cuffed	<40ml	5

### Reinforced PVC Supraglottic mask

22LMSRP10	②	infants up < 5kg	size 1	●	5.9	8.2	3.5	<4ml	5
22LMSRP15	②	infants 5-10kg	size 1.5	●	6.9	10	4	<7ml	5
22LMSRP20	②	children 10-20kg	size 2	○	6.9	10	4.5	<10ml	5
22LMSRP25	②	children 20-30kg	size 2.5	●	7.4	10.5	5	<14ml	5
22LMSRP30	②	children 30-50kg	size 3	●	7.9	12	6 cuffed	<20ml	5
22LMSRP40	②	adults 50-70kg	size 4	●	7.9	12	6 cuffed	<30ml	5
22LMSRP50	②	adults 70-100kg	size 5	●	8.8	13	7 cuffed	<40ml	5



CODE	WEIGHT	SIZE	ID	OD	ET TUBE	VALVE	UNITS
------	--------	------	----	----	---------	-------	-------

**MRI compatible silicone Supraglottic mask** No interference guaranteed in an MRI unit (magnets).

22LMRI10	@	infants up to 5kg	size 1	●	5	8	3.5	<4ml	5
22LMRI15	@	infants 5-10kg	size 1.5	●	6	10	4	<7ml	5
22LMRI20	@	children 10-20kg	size 2	○	7	11	4.5	<10ml	5
22LMRI25	@	children 20-30kg	size 2.5	●	8.5	13	5	<14ml	5
22LMRI30	@	children 30-50kg	size 3	●	10	15	6 cuffed	<20ml	5
22LMRI40	@	adults 50-70kg	size 4	●	10	15	6 cuffed	<30ml	5
22LMRI50	@	adults 70-100kg	size 5	●	11	16.5	7 cuffed	<40ml	5

**Reusable Supraglottic mask**

22LMA10RE		infants <5kg	size 1	●	5	8	3.5	<4ml	5
22LMA15RE		infants 5-10kg	size 1.5	●	6	10	4	<7ml	5
22LMA20RE		children 10-20kg	size 2	○	7	11	4.5	<10ml	5
22LMA25RE		children 20-30kg	size 2.5	●	8.5	13	5	<14ml	5
22LMA30RE		children 30-50kg	size 3	●	10	15	6 cuffed	<20ml	5
22LMA40RE		adults 50-70kg	size 4	●	10	15	6 cuffed	<30ml	5
22LMA50RE		adults 70-100kg	size 5	●	11	16.5	7 cuffed	<40ml	5

SAFE-T-BAG® code: 22STB100



**SAFE-T-BAG® enhanced airway attachment device**

The exciting new Safe-T-Bag vastly enhances current practice. Featuring a translucent body, exhalation micron-filter protection and capnography capability, the Safe-T-Bag will improve post-operative safety and care within the OT and PACU environment. Creating a safer environment for your patients and staff.

**SAFE-T-BAG® Features**

- 1 Bag stands upright for optimal visibility
- 2 Highly compliant bag material for indicating shallow respiration or breathing effort
- 3 Translucent body allows visualisation of foreign material or blockages in the device
- 4 Capnography port for monitoring CO2
- 5 Micron-filter on expiratory port with bacterial viral protection for OT and PACU staff. Tested efficacy of 99.9+% for airborne contaminants
- 6 Standard O2 fitting
- 7 Standard 15mm airway device connector



Individually packaged and labelled to improve handling and storage safety, with lot number traceability!





## Disposable laryngoscope blades



Standard Miller blade: 2271000SSF



Standard Macintosh blade: 226000SSF



Standard Laryngoscope handle: 226FM

DESCRIPTION	FIBRE OPTIC	PLASTIC	SIZE	UNITS
-------------	-------------	---------	------	-------

### Standard Miller laryngoscope blades (non sterile)

Standard Miller blade	2271000SSF	②	_____	size 000	20	
Standard Miller blade	227100SSF	②	_____	size 00	20	
Standard Miller blade	227000SSF	②	227000	②	size 0	20
Standard Miller blade	227001SSF	②	227001	②	size 1	20
Standard Miller blade	227002SSF	②	227002	②	size 2	20
Standard Miller blade	227003SSF	②	_____	size 3	20	
Standard Miller blade	227004SSF	②	_____	size 4	20	

More handle options available in the following sizes Large, medium, small, stubby, infant and paediatric. LED and Fibre optic. Contact us [sales@meditechsystems.co.uk](mailto:sales@meditechsystems.co.uk)

DESCRIPTION	FIBRE OPTIC	PLASTIC	SIZE	UNITS
-------------	-------------	---------	------	-------

### Standard Macintosh laryngoscope blades (non sterile)

Standard Macintosh blade	226000SSF	②	_____	size 0	20	
Standard Macintosh blade	226001SSF	②	_____	size 1	20	
Standard Macintosh blade	226002SSF	②	226002	②	size 2	20
Standard Macintosh blade	226003SSF	②	227003	②	size 3	20
Standard Macintosh blade	226004SSF	②	227004	②	size 4	20
Standard Macintosh blade	226005SSF	②	_____	size 5	20	

### Macintosh flexible tip laryngoscope blades

Flexi tip Macintosh blade	229002	_____	_____	size 2	5
Flexi tip Macintosh blade	229003	_____	_____	size 3	5
Flexi tip Macintosh blade	229004	_____	_____	size 4	5

DESCRIPTION	FIBRE OPTIC	LED	UNITS
-------------	-------------	-----	-------

### Laryngoscope Handles for fibre optic and LED blades

Standard handles	226FM small (2AA batteries)	226LS small (2AA batteries)	1
Standard handles	226FS medium (2C batteries)	226LM medium (2C batteries)	1

DESCRIPTION	STANDARD	REINFORCED	NASAL PREFORMED	ORAL PREFORMED	UNITS
-------------	----------	------------	-----------------	----------------	-------

### ET Tubes. All codes shown are 3.0mm diameter

Uncuffed ET tube	22ET30	②	22ETR30M	②	22NTP35M (3.5mm)	22OTP30M	10
Cuffed ET tube	22ETC30M	②	22ETCR30M	②	_____	_____	10

Endotracheal(ET) tubes are available in various sizes. Contact us for more information



**Insufflation device: *RAPID02*<sup>®</sup>**

A safer way of delivering oxygen in a 'can't intubate can't oxygenate' (CICO) scenario. Simple and effective use within a difficult scenario. Both sterile and non-sterile options are single use.



DESCRIPTION	CODE	UNITS
-------------	------	-------

***RAPID02*<sup>®</sup> cricothyroidotomy insufflation device**

RAPID02 cricothyroidotomy insufflation device (non-sterile)	2290-001	5
RAPID02 cricothyroidotomy procedure pack (Sterile) includes procedure tray, 2 x 14g cannula with 5ml syringe	SU2290-002	5

***RAPID02*<sup>®</sup> BENEFITS**

Introducing the NEW Rapid02, a safer way of delivering oxygen in a 'can't intubate can't oxygenate' (CICO) scenario.

Our Rapid02 is designed by anaesthetists to meet the critical need for a safer oxygen delivery device. For use when performing emergency jet oxygenation via cannula cricothyroidotomy.

**The problem:** many commonly used devices for jet ventilation (via cannula cricothyroidotomy) do not allow adequate flow and pressure release during the expiratory pause. If the patient has upper airway obstruction there is a real risk of lung hyperinflation.

**The solution:** Placing the thumb over the hole causes lung inflation and effective oxygenation. When the thumb is removed, expiration of gas occurs. With cautious jetting the risk of significant residual pressure prior to re-inflation is reduced.

**Benefits**

- Flow and pressure release during 'expiration' enables lung deflation via cannula.

**This reduces risk of**

Lung hyperinflation and barotrauma.  
 Raised intrathoracic pressure that may impair cardiac output.  
 Sensory feedback of cannula occlusion.  
 Cost point that enables a Rapid02 to be kept in every theatre for immediate use in a time critical emergency.

- Easy to use.
- Manufactured in the UK to full CE standards.

DESCRIPTION	CODE	UNITS
-------------	------	-------

**Bougie Coude tip/Introducers**

Paediatric bougie coude tip 10Fr	220211PD	10
Paediatric bougie coude tip 10Fr vented	220211PDV1	10
Adult bougie coude tip 15Fr	220212AD1	10
Adult bougie coude tip 15Fr vented	220212ADV	10
Adult bougie coude tip 14Fr vented	220212V14	10

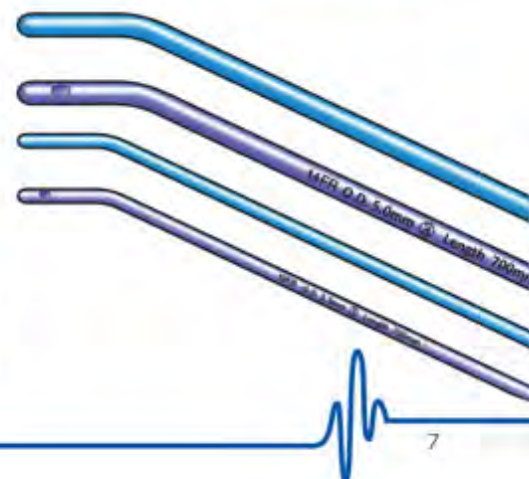

### Catheter mounts

Available with either **MEDI FLEX™**: a standard flexible tubing, **X-Tendible™**: a length adjustable tubing system and smoothbore tubing with various fixed or swivel elbows and connectors.

PLEASE NOTE THE CODES suffixes: **S**: STANDARD **GS**: GAS SAMPLING **DS**: DOUBLE SWIVEL

DESCRIPTION	LENGTH	CODE	UNITS
-------------	--------	------	-------

#### MEDI FLEX™ standard tubing. Disposable catheter mounts.



Standard elbow.	150mm	22I50S	50
Gas sampling elbow.	150mm	22I50GS	50
Double swivel elbow.	150mm	22I50DS	50
Straight connector.	150mm	22I50	50

#### Smoothbore tubing. Disposable catheter mounts.



Standard elbow.	150mm	22SB150S	50
Gas sampling elbow.	150mm	22SB150GS	50
Double swivel elbow.	150mm	22SB150DS	50
Straight connector.	150mm	22SB150	50

#### X-Tendible™ tubing. Disposable catheter mounts.



Standard elbow.	150mm	22X150S	50
Gas sampling elbow.	150mm	22X150GS	50
Double swivel elbow.	150mm	22X150DS	50
Straight connector.	150mm	22X150	50



**Silver Sentinel** antimicrobial systems. Available on all systems apart from smoothbore. Look out for the shield, all codes end with AM.



## Patient Elbow connection

All options available with a variety of elbow connections and ports. All Meditech port caps are retainable for safety, they are fixed to the port connectors to ensure that they cannot be misplaced in use. Dräger (DR) is a registered trade name.

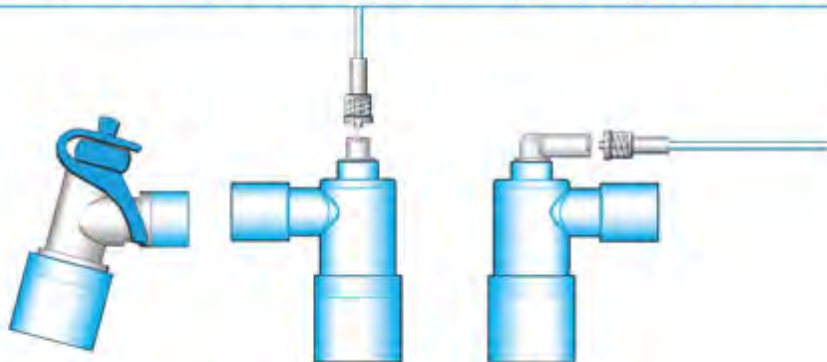

DESCRIPTION	CODE	UNITS
-------------	------	-------

### Connector options

Standard elbow connector	221577	50
Ported elbow connector	221577P	50
Gas sampling elbow connector	221577GSE	50
Double swivel elbow connector	221577DSP	50



221577



221577DSP

## Elbow Connectors



## T Piece Connectors



## T Piece Connectors

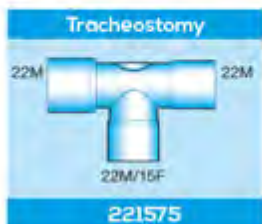
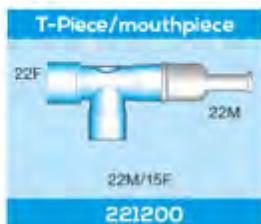
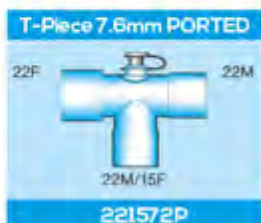
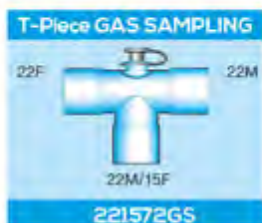
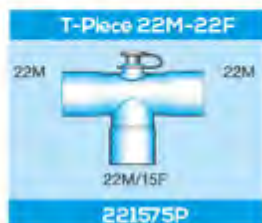

## Y Piece Connectors





All of our  
HEPA  
filters reach  
99,999+%  
efficiency

## MEDI STAT™ Filters

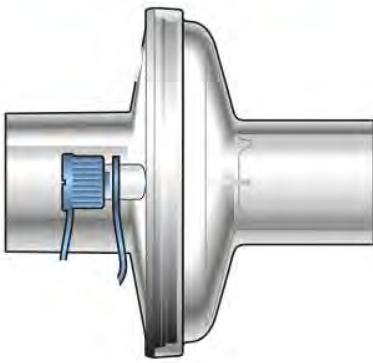

Standard filter: 222832



Combination filter: 222835

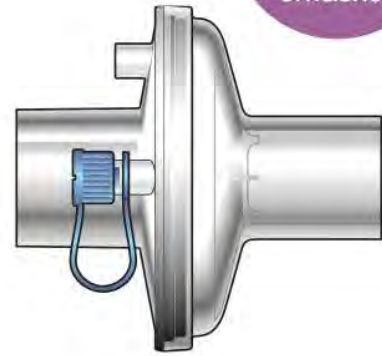

## ELECTROSTATIC FILTRATION

The media used in the MEDI STAT™ filter is electrostatically charged. This is a finely meshed membrane, which filters particles down to 2 microns in diameter. The fibres in the filter are electrostatically charged with both positive and negative charge. This causes bacteria smaller than 2 microns to be attracted to the fibres. All bacteria will be either positively or negatively charged. This results in high filtration without high resistance to flow, a major advantage over mechanical pleated filters.

This diagram illustrates the electrostatic process of the MEDI STAT™ filtration.



3-in-1 catheter mount kit: 222835XMMS

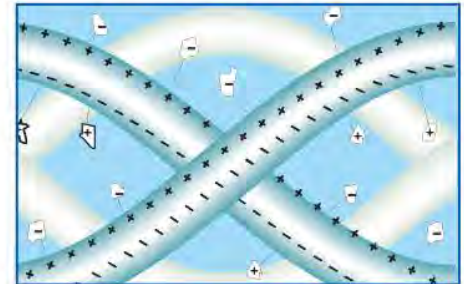

PRODUCT	STANDARD	STERILE	UNITS
---------	----------	---------	-------

### MEDI STAT™ filters bacterial, viral and HME

Bacterial/viral and HME (foam)	222835	SU222835	50
Bacterial/viral and HME (paper)	222836	SU222836	50
Bacterial/viral	222832	SU222832	50
Bacterial/viral/HME (paper) mini	222833	SU222833	50
Bacterial/viral/HME (foam) mini	224318	SU224318	50
Bacterial/viral/gas sampling port	224319	SU224319	50
Bacterial/viral/HME (foam) Neonate	222835N	SU222835N	50
Bacterial/viral/gas sample port/no HME	222832G	SU222832G	50

PRODUCT	CODES	UNITS
---------	-------	-------

### MEDI STAT™ filters bacterial, viral filter kits

Bacterial/viral and HME (foam) & elbow	222835-1577	50
Bacterial/viral and HME mini (foam) & elbow	224318-1577	50
Bacterial/viral 3-in-1 kit with X-Tendible™ tubing	222836XMMS	50
Bacterial/viral 3-in-1 kit with MEDI FLEX tubing	222836MMS	50
Bacterial/viral 3-in-1 kit with X-Tendible™ tubing	222835XMMS	50
Bacterial/viral filter and HME (foam) with MEDIFLEX™ tubing	222835MMS	50
Bacterial/viral and mouthpiece	22EN2832	50



## MEDI PLEAT™/HEPA filters



Large MEDI PLEAT filter: 32501



Medium MEDI PLEAT filter: 32501MD

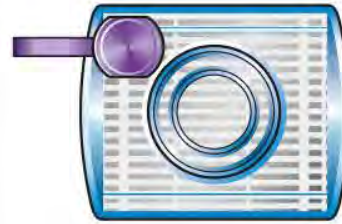

Small MEDI PLEAT filter: 32501M

All of our HEPA filters reach 99.999+% efficiency

## HEPA (High-Efficiency Particulate Air)

HEPA stands for High-Efficiency Particulate Air. A HEPA filter consists of pleated glass fibre material and is a mechanical type of air filter; it works by forcing air through a fine mesh that traps particles, this makes it the most efficient type of filter for bacterial and viral filtration. The pleated fibres offer a tortuous pathway through the filter allowing free flow of gas but impacting particles on route through the mesh. Meditech HEPA filters offer a minimum of 99.999+% bacteria and viral filtration efficiency.

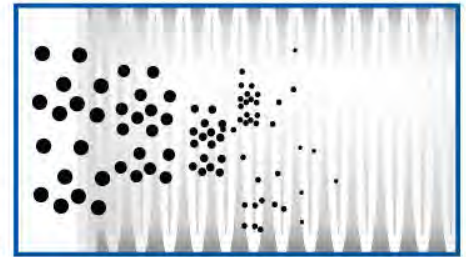

This diagram illustrates the tortuous pathway process of HEPA filtration.

PRODUCT	CODE	UNITS
<b>MEDI PLEAT™ HEPA (mechanical) pleated filter</b>		
HEPA bacterial/viral filter hydrophobic large	32501	50
HEPA bacterial/viral filter hydrophobic medium	32501MD	50
HEPA bacterial/viral filter hydrophobic small	32501M	50
<b>MEDI PLEAT™ HEPA (mechanical) pleated filter 3 in 1 kits</b>		
HEPA 3-in-1 kit X-Tendible™ tubing small	32501MXMMS	50
HEPA 3-in-1 kit X-Tendible™ tubing medium	32501MDXMMS	50
HEPA 3-in-1 kit standard tubing small	32501MMMS	50
HEPA 3-in-1 kit standard tubing medium	32501MDMMS	50
HEPA elbow small	32501M-1577	50
<b>MEDI FOAM™ and MEDI TRACH™ filter</b>		
HME, no sample port	22800705	50
HME with sample port	22800707	50
HME without sample port	22HME501M	50
MEDITRACH™ O2	2201082	50

3-in-1 catheter mount kit: 32501MXMMS

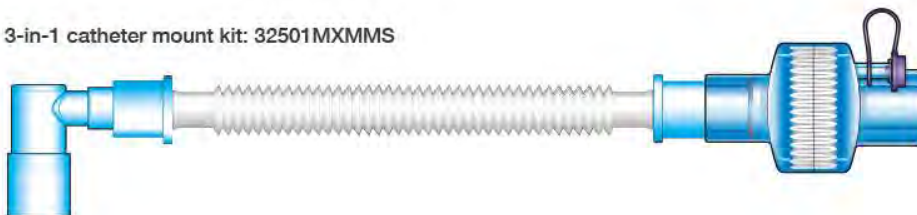

HEPA bacterial/viral filter Small with elbow: 32501M-1577

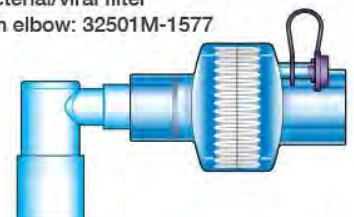



## Face masks

All masks available with or without hook rings. All hook rings colour coded for easy identification. Suffix relevant code with H.

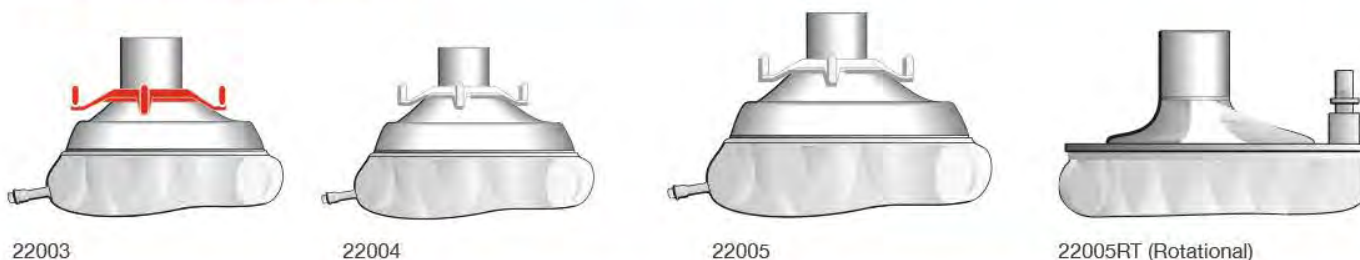

SIZE	HOOK RING	STANDARD	ECONOMY	SCENTED	UNITS
------	-----------	----------	---------	---------	-------

### Anaesthesia air cushion mask

Large adult size 5	22005H	●	22005	22005E (No valve)	22015	50
Medium adult size 4	22004H	●	22004	22004E (No valve)	22014	50
Small adult size 3	22004H	●	22003	22003E (No valve)	22013	50
Child size 2	22002H	●	22002	22002E (No valve)	22012	50
Infant size 1	22001H	○	22001	22001E (No valve)	22011	50
Neonate size 0	22000H	●	22000	22000E (No valve)	22010	50

### Rotational masks with valve

Large adult size 5	22005RTH	●	22005RT	—	—	50
Medium adult size 4	22004RTH	●	22004RT	—	—	50
Small adult size 3	22003RTH	●	22003RT	—	—	50
Child size 2	22002RTH	●	22002RT	—	—	50
Infant size 1	22015RTH	○	22001RT	—	—	50
Neonate size 0	220005RTH	●	22000RT	—	—	50



SIZE	ECO	UNITS
------	-----	-------

### Anatomical ECO masks

Mask Size 6	220025ECO	50	●
Mask Size 5	220024ECO	50	●
Mask Size 4	220023ECO	50	○
Mask Size 3	220022ECO	50	●
Mask Size 2	220021ECO	50	●
Mask Size 1	220020ECO	50	●

SIZE	SILICONE	UNITS
------	----------	-------

### Anatomical silicone masks

Mask Size 5	220025	10
Mask Size 4	220024	10
Mask Size 3	220023	10
Mask Size 2	220022	10
Mask Size 1	220021	10
Mask Size 0	220020	10



## Anaesthetic Mapleson breathing systems

Introducing the Meditech range of anaesthetic Mapleson breathing systems. Available with Silver Sentinel tubing offering an antimicrobial system.

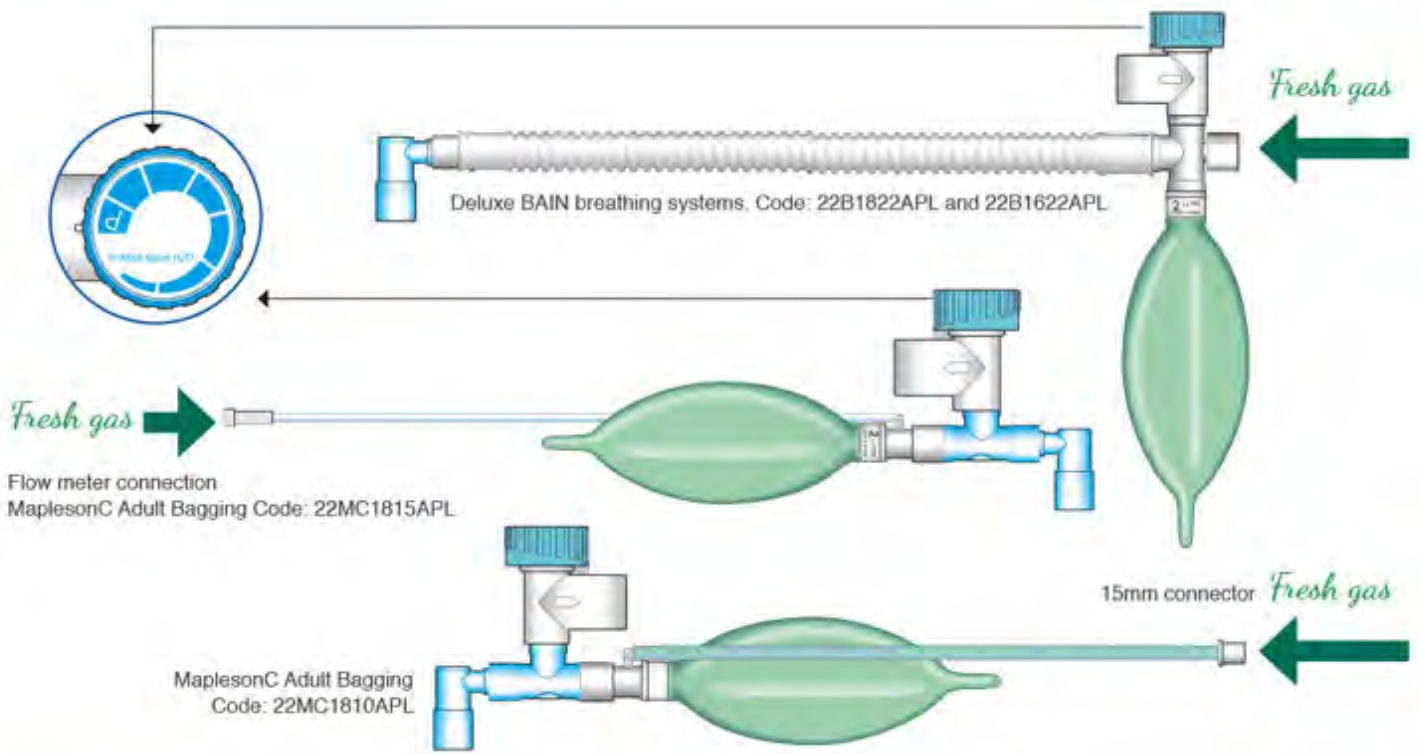

DESCRIPTION	LENGTH	CODE	UNITS
<b>Mapleson D systems</b>			
MaplesonD/Bain (Adult)	1.8m	22B1822F7F	10
MaplesonD/Bain (Adult)	1.6m	22B1622F7F	10
MaplesonD/Bain (Silver Sentinel)	1.8m	22B1822F7F-AM	10
MaplesonD/APL valve & 2L bag (Deluxe Bain)	1.8m	22B1822APL	10
MaplesonD/APL valve & 2L bag (Deluxe Bain)	1.6m	22B1622APL	10
MaplesonD/APL valve & 2L bag (Silver Sentinel)	1.8m	22B1822APL-AM	10
MaplesonD/APL valve & 2L bag (Deluxe Bain)	5.4m	22B5422APL	10
<b>Mapleson C systems</b>			
MaplesonC system with APL valve & 2L bag	1.8m	22MC1810APL	10
MaplesonC system with APL valve & 2L bag	1.6m	22MC1610APL	10
MaplesonC system with APL valve & 2L bag	1.8m	22MC1810APL-AM	10



**Silver Sentinel** antimicrobial systems. Available on all systems apart from smoothbore. Look out for the shield, all codes end with AM.

## Anaesthetic breathing systems

Mapleson A Magill system (1.8m) 22mm MEDJ FLEX standard tube with 2L reservoir bag and adult APL Valve. Code: 22MAM1822APL

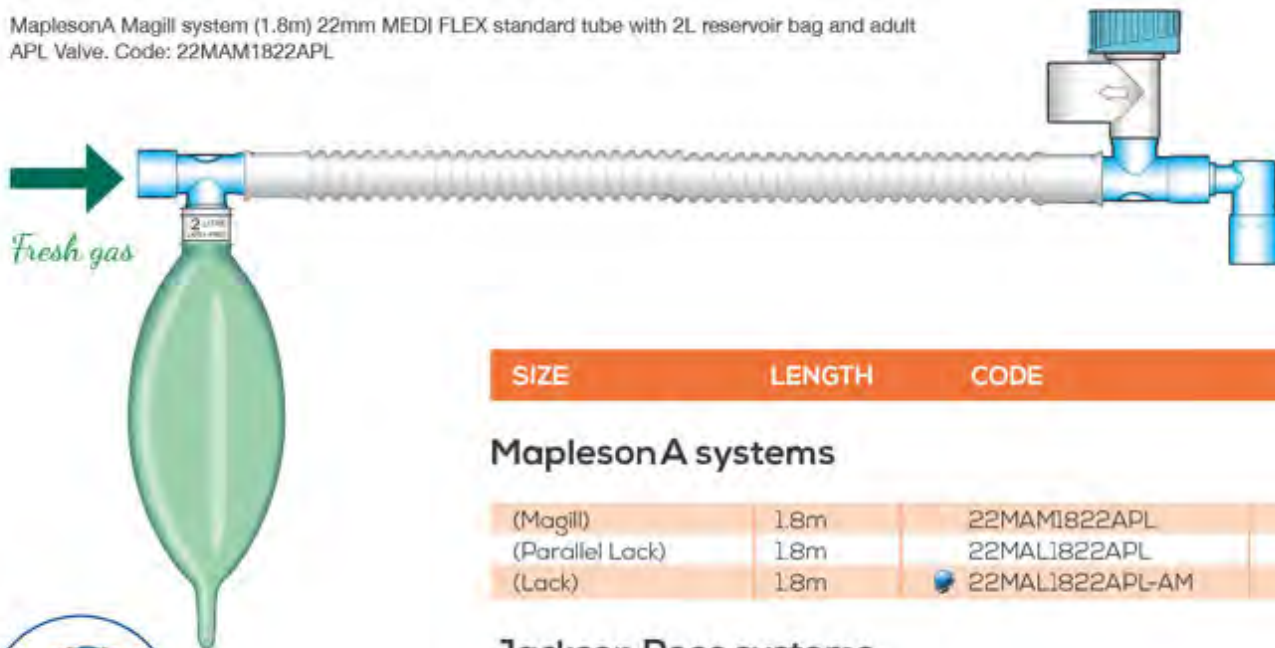

APL valve

SIZE	LENGTH	CODE	UNITS
------	--------	------	-------

### Mapleson A systems

(Magill)	1.8m	22MAM1822APL	10
(Parallel Lack)	1.8m	22MAL1822APL	10
(Lack)	1.8m	22MAL1822APL-AM	10

### Jackson Rees systems

Standard	0.3m	22JR0322	20
Standard/0.5L bag	0.3m	22JR1622	20
Standard/1L bag	0.3m	22JR03221L	20
Standard/2L bag	0.3m	22JR03222L	20

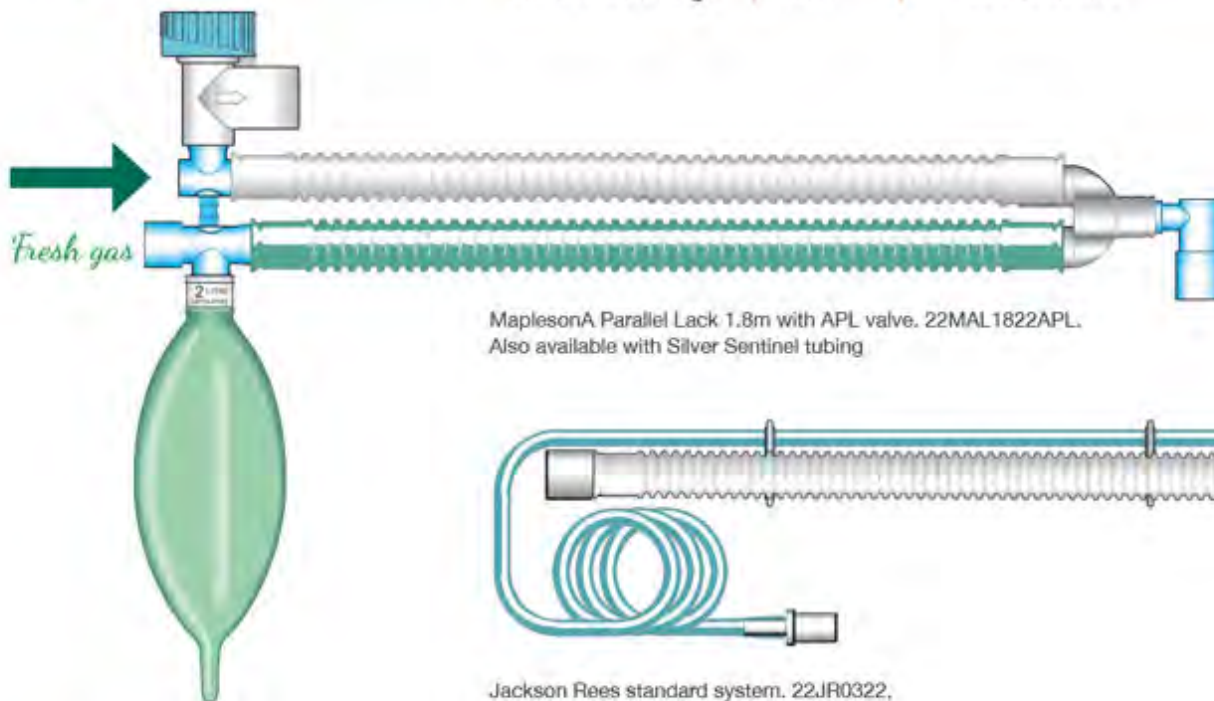

Mapleson A Parallel Lack 1.8m with APL valve. 22MAL1822APL. Also available with Silver Sentinel tubing

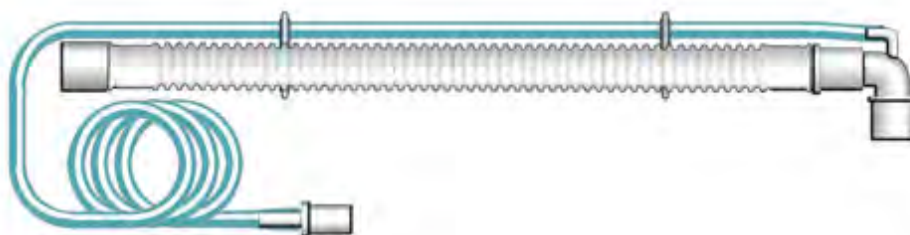

Jackson Rees standard system. 22JR0322.



**Silver Sentinel antimicrobial systems.** Available on all systems apart from smoothbore. Look out for the shield, all codes end with AM.



DESCRIPTION	LENGTH	CODE	UNITS
-------------	--------	------	-------

### MaplesonF systems

MaplesonF system (Infant T)	1.6m	22MF1615	
MaplesonF system (Infant T) (Silver Sentinel)	1.6m	22MF1615-AM	
MaplesonF system (Infant T) with APL valve	1.6m	22MF1615APL	
MaplesonF system (Ayles T) with APL valve	1.6m	22AT1610S	
MaplesonF system (Ayles T) with APL valve 35cm	1.6m	22AT1610SAPL	

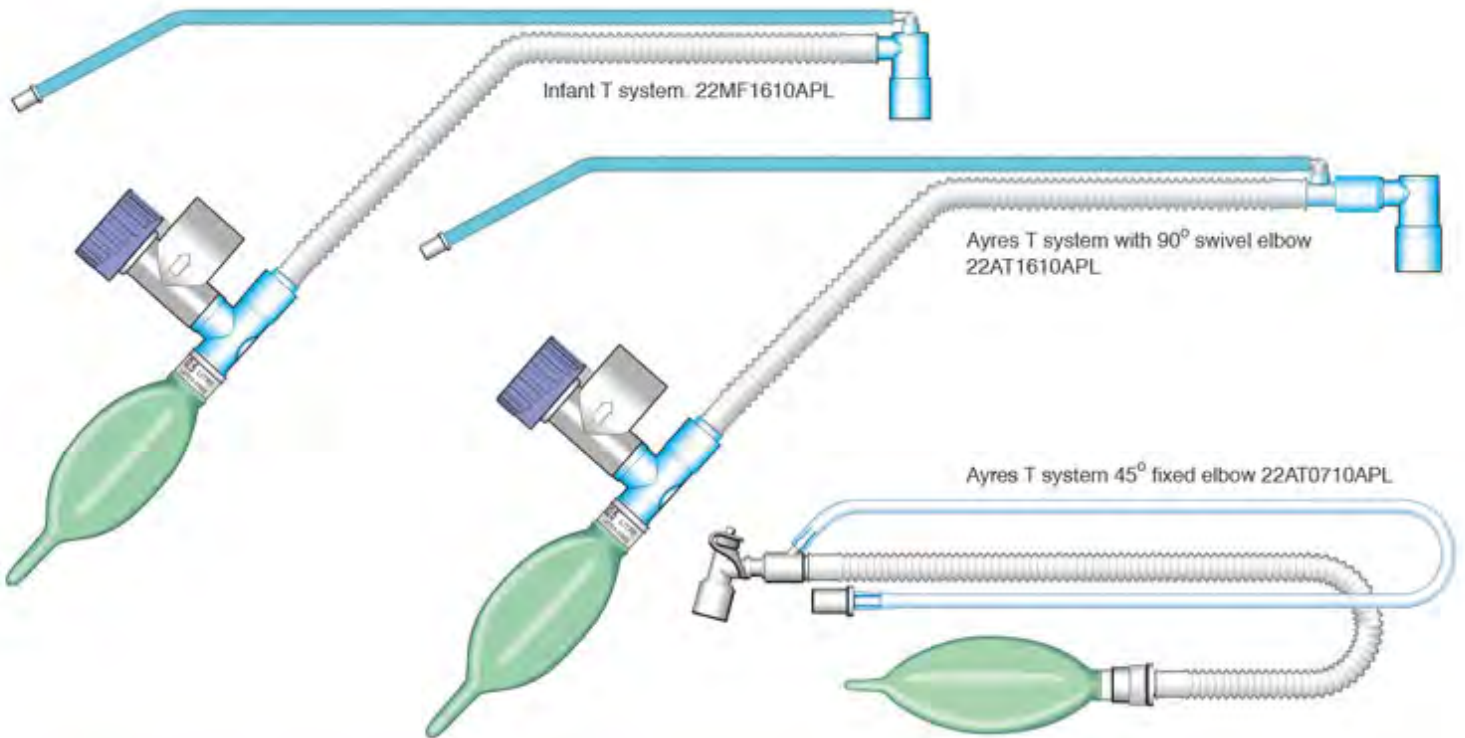

### CONNECTOR OPTIONS

#### T Connector options

Static 45° angle and swivel elbow 90° angle. Please note we offer both options of connectors

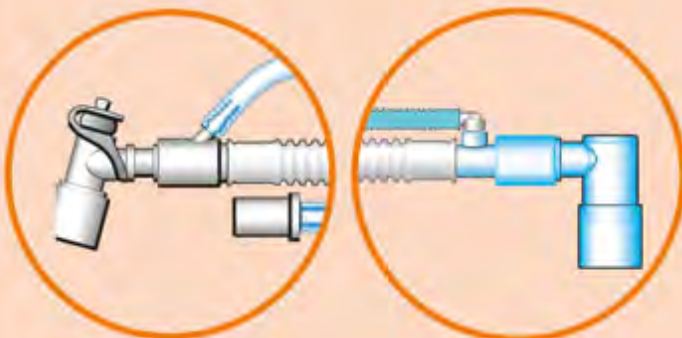

#### Connection options

We offer several different interchangeable connectors.



15mm connector is ready if machine connection is required. Add yellow adaptor to allow oxygen flowmeter connection.

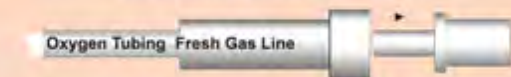

15mm connector is ready if machine connection required. Pull out 15mm Connector to allow oxygen flowmeter connection.



Both types above also have extra adaptor to allow 22mm connection also.



## Circle systems



Parallel system

Meditech's X-Tendible™ tubing is a great space saver



Smoothbore tubing



X-Tendible tubing

PRODUCT	LENGTH	CODE	UNITS
---------	--------	------	-------

### Parallel systems

Adult	1.8m	22P1822FF	10
Parallel system (Silver Sentinel)	1.6m	22P1622FF-AM	10
Standard system	2.4m	22P2422FF	10
1m limb and 2L bag (Silver Sentinel)	1.6m	22P1622FM102L-AM	10
1m limb and 2L bag	1.8m	22P1822FM102L	10
1m limb and 2L bag	2.4m	22P2422FM102L	10
1m limb and 2L bag (Silver Sentinel)	2.4m	22P2422FM102L-AM	10
CO2 monitoring line	2.4m		
1m limb 2L bag and arm connector		22P1822FF10ELCGS	10
CO2 monitoring line	2.4m		
1m limb 2L bag and arm connector		22P2422FF10ELCGS	10
Paediatric	1.6m	22P1615FF	10
Paediatric (Silver Sentinel)	1.6m	22P1615FF-AM	10

### Smoothbore systems

Smoothbore system	1.6m	22SB1622FF	10
Smoothbore system	1.8m	22SB1822FF	10
Smoothbore system	2.4m	22SB2422FF	10
Smoothbore system with water trap	1.6m	22SBT1622MM	10
Smoothbore system with 2watertraps	1.6m	22SBTT1622MM	10
Smoothbore system dual heated wire with 0.5m limb	1.6m	22SBHWW1622MM	10
Smoothbore system paediatric	1.6m	22SB161522FF	10

### X-Tendible systems

X-Tendible™ system	1.6m	22XP1622FF	10
X-Tendible™ system	2.0m	22XP2022FF	10
X-Tendible™ system 1m limb & 2L bag	2.0m	22XP2022FF102L	10
X-Tendible™ system	1.6m	22XP3022FF	10
X-Tendible™ system 2m limb & 2L bag	3.0m	22XP3022FM202L	10



## Circle systems

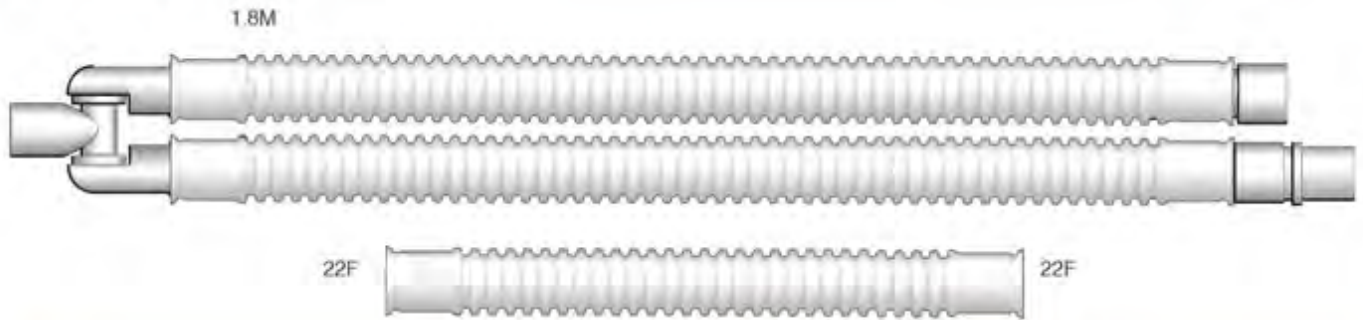

PRODUCT	LENGTH	CODE	UNITS
---------	--------	------	-------

## Swivel systems

Swivel Y adult system	1.6m	22SW1622FF	10
Swivel Y adult system	1.8m	22SW1822FF	10
Swivel Y adult system	2.4m	22SW2422FF	10
Swivel Y adult system	3.0m	22SW3022FF	10
1m limb and 2L bag with 22mm connectors	1.6m	22SW1622FM102L	10
1m limb and 2L bag with 22mm connectors	2.4m	22SW2422FM102L	10
1m limb and 2L bag with 22mm connectors	3.0m	22SW3022FM102L	10

## MEDI LIMB™ co-axial systems

2L bag and integral CO2 monitoring	1.6m	22UN1625102L	10
2L bag and integral CO2 monitoring	2.4m	22UN2425102L	10
2L bag and integral CO2 monitoring	3.2m	22UN3225102L	10
2L bag APL valve and integral CO2 monitoring	1.6m	22UN1625APL	10
2L bag APL valve and integral CO2 monitoring	2.4m	22UN2425APL	10
2L bag and integral CO2 monitoring	1.6m	22UN1625102L	10
2L bag and integral CO2 monitoring	1.6m	22UN1625102L	10
2L bag and integral CO2 monitoring	1.6m	22UN1625102L	10



## TIMETAG

A time management device to reduce your manual recordings and record daily progress. Assists with change frequency, traceability and expiry dates.



## Anaesthesia breathing systems for GE Healthcare® Carestation®

### Breathing systems for the Aisys®, Avance®, and Aespire® Carestation®\*

Breathing Systems with fixed elbow. 22P162210ELS

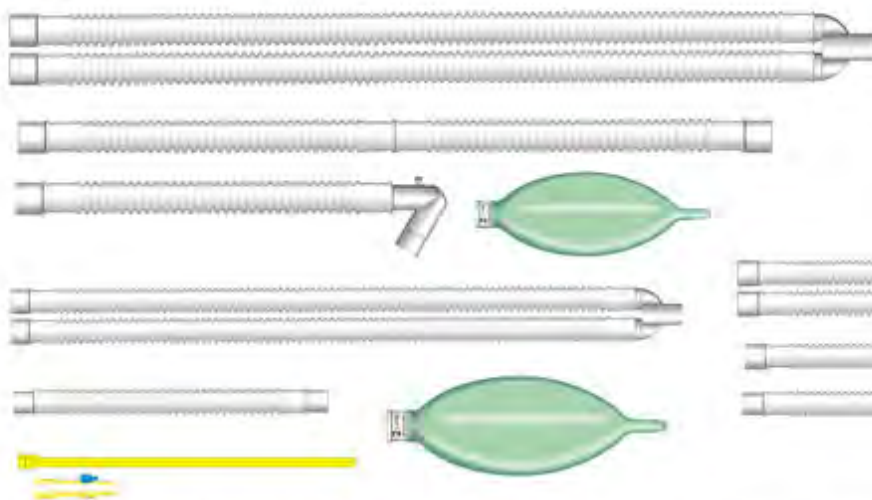

Customisation of Carestation® breathing systems available upon request. Visit us at [meditechsystems.co.uk](http://meditechsystems.co.uk)



Breathing Systems with spirometry kit. 22P162216CSP

Breathing Systems for the ADU Carestation® 22P16221016ADU

\*Aisys, Avance, Aespire, Carestation and ADU are all trademarks of GE Company.

PRODUCT	LENGTH	CODE	UNITS
---------	--------	------	-------

### Breathing systems for GE Healthcare® Carestation®

Fixed elbow, 2L bag & 1.6m bag limb with click elbow	1.6m	22P162216ELS	10
Fixed elbow, 2L bag & 1.0m bag limb with click elbow	1.6m	22P162210ELS	10
Fixed elbow, 2L bag & 1.0m bag limb & spirometry kit	1.6m	22P162210CSP	10
Fixed elbow, 2L bag & 1.6m bag limb & spirometry kit	1.6m	22P162216CSP	10
Fixed elbow, 2L bag & 1.0m bag limb & extra limb	1.6m	22P16221010ADU	10
Fixed elbow, 2L bag & 1.6m bag limb & extra limb	1.6m	22P16221016ADU	10

### Breathing bags/reservoir bags ( latex free)

Reservoir bag 3L 22F		221300	20
Reservoir bag 2L 22F		221200	20
Reservoir bag 2L soft 22F		221200ES	20
Reservoir bag 1L 22F		221100	20
Reservoir bag 1L 15F		221115	20
Reservoir bag 0.5L 15F		221050	20



**Silver Sentinel** antimicrobial systems. Available on all systems apart from Smoothbore. Look out for the shield, all codes end with AM.





## Water trap systems

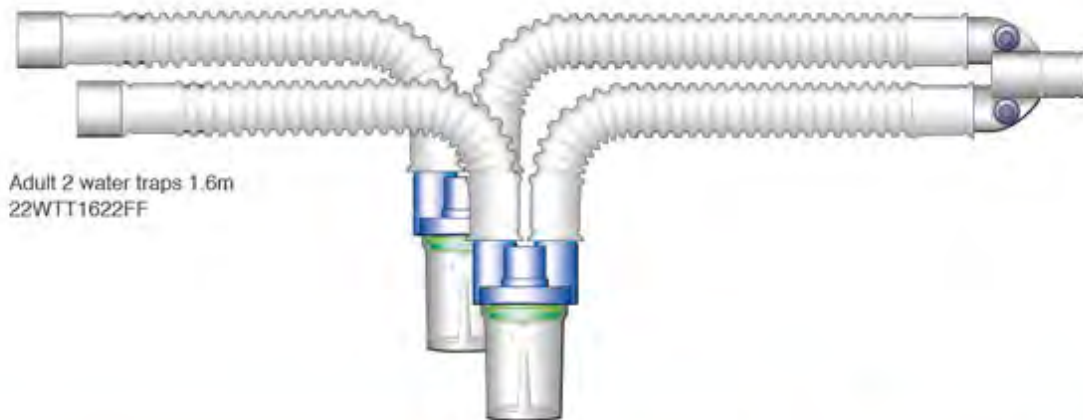

PRODUCT	LENGTH	CODE	UNITS
---------	--------	------	-------

## Water trap systems

Adult water trap	2m	22WT22220	20
Adult 2 water traps	1.6m	22WTT1622FF	10
Adult water trap circuit with Dräger port	1.6m	22YP162208DR	10
Adult system with water traps. Dräger port & limb	1.6m	22PWTT1622FFDR	10
Adult Smoothbore system, 2 water traps & elbow	1.6m	22SBETT1622FF	10
Neonate with water trap	1.6m	22WTT1610NEO	10

## Paediatric water trap systems

Paediatric water trap & luer elbow	1.6m	22EWT161522FF	20
Paediatric Smoothbore 1 water trap	1.6m	22SBT1615MM	10
Paediatric Smoothbore 1 water trap & 1m limb	1.6m	22SBT1615MM10	10

## X-Tendible™ water trap systems

1 water trap 2L bag GS elbow 1m limb	2m	22XT2022FF102L	20
1 water trap 2L bag GS elbow 1.5m limb	2m	22XT2022FF152L	10

## Introduction to Meditech's ventilator breathing systems

Meditech's breathing systems work on an interchangeable design and are a key component for the critical care of patients. The full range of single, dual and heated wire systems, available in all the usual configurations ie: adult, paediatric, neonatal. Please contact us for more information or visit us at: [meditechsystems.co.uk](http://meditechsystems.co.uk)

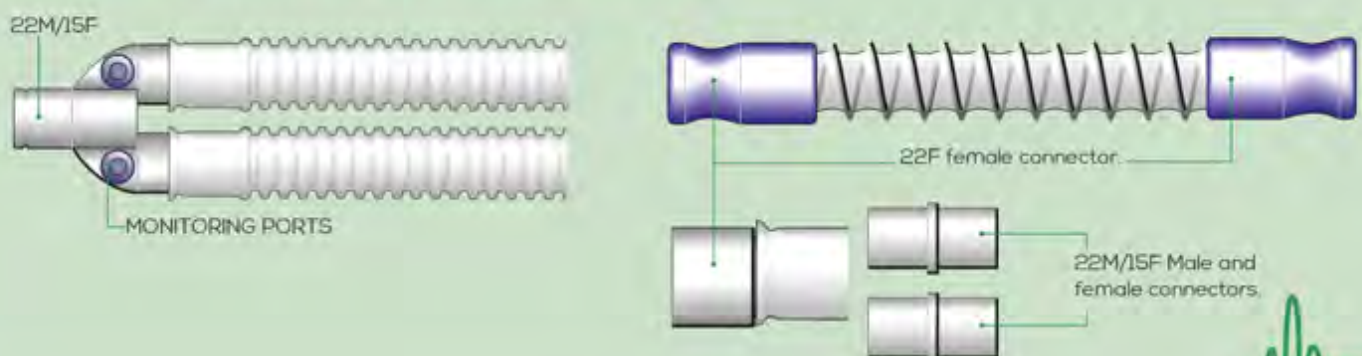

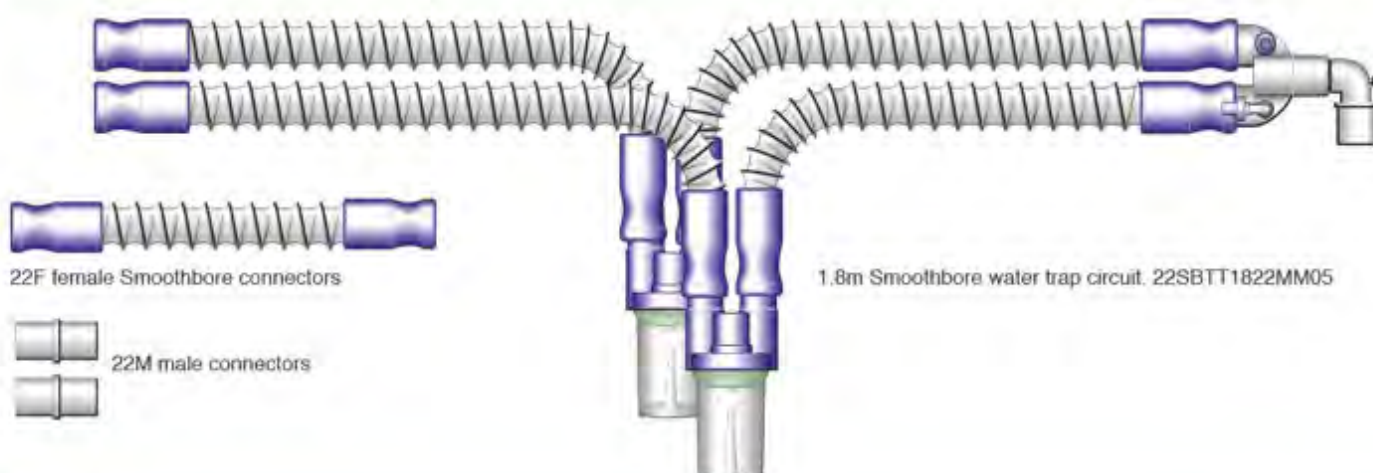

PRODUCT	CODE	UNITS
---------	------	-------

### Smoothbore water trap systems

Paediatric 1 water trap	22SBT1615MM	20
Paediatric 1 water trap & 1.0m limb	22SBT1615MM10	10
Adult 1 water trap	22SBT1622MM	10
Adult 1 water trap & 1.0m limb	22SBT1622MM10	10
Adult 2 water traps	22SBTT1622MM	10
Adult 2 water traps, 0.5m limb	22SBTT1622MM05	10
Adult 2 water traps, 0.5m limb	22SBTT1822MM05	10

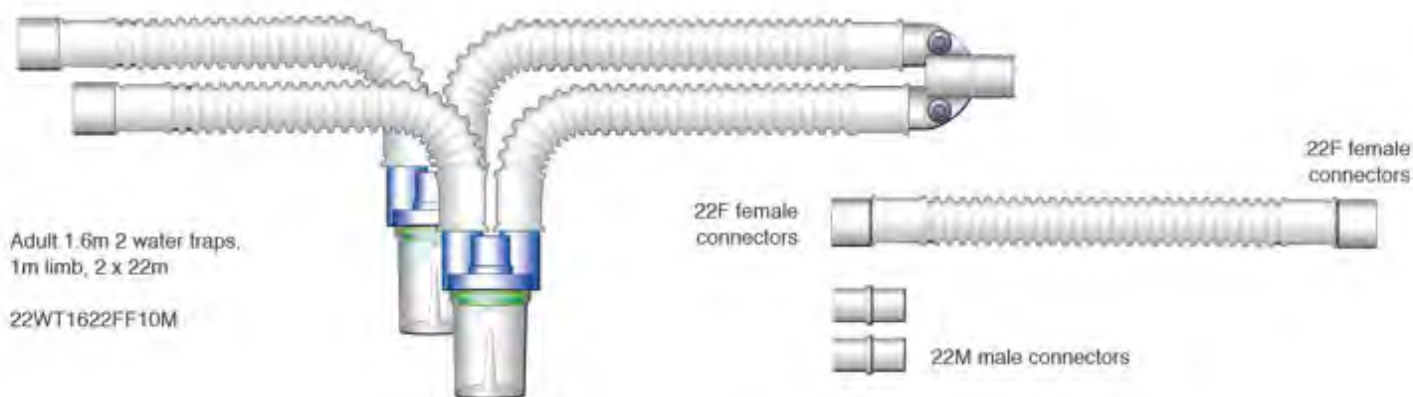

PRODUCT	CODE	UNITS
---------	------	-------

### Ported Y water trap systems

Adult 1.6m 2 water traps, 1m limb, 2 x 22m	22WT1622FF10M	10
Dräger compatible 1.6m 2 water traps, 1m limb, 2 x 22m	22WT1622FF10MD	10
Dräger compatible 1.8m 2 water traps, 1m limb, 2 x 22m	22WT1822FF10MD	10
1.6m detachable 2 water traps, 1m limb, 2 x 22m	22WTD1622FF10M	10
1.8m detachable 2 water traps, 1m limb, 2 x 22m	22WTD1822FF10M	10
1.6m 2 water traps, 1m limb, 2 x 22m	22WTT1622FF10M	10
Dräger compatible 1.6m 2 water traps, 1m limb, 2 x 22m	22WTT1622FF10MD	10
1.6m 2 water traps, 1m limb, 2 x 22m	22XT1622FF10M	10



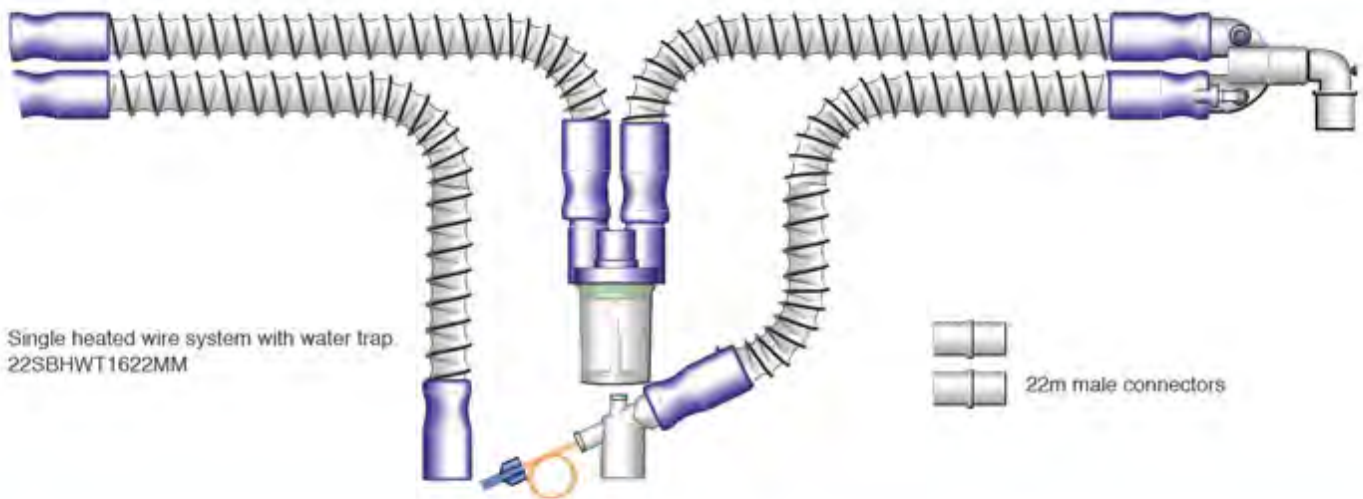

PRODUCT	LENGTH	CODE	UNITS
<b>Single heated wire systems</b>			
Single heated wire system 1m limb	1.6m	22HW1622FF10M	10
Single heated dual ventilator system	1.6m	22HW162202	10
Single circuit water trap 1m limb	1.6m (Universal)	22HW1622FF10MU	10
Single heated wire system with water trap, 1m limb	1.6m	22HWT1622FF10M	10
Single heated wire system with water trap, 1m limb	1.6m (Universal)	22HWT1622FF10MU	10
Single heated wire system with Smoothbore tubing	1.6m	22SBHW1622MM	10
Single heated wire system with 0.5m limb	(Universal)	22SBHW1622MMU	10
Single heated wire system (Silver Sentinel)	1.6m	22HW1622-AM	10
Single heated wire system with 1m limb	1.6m	22HW1622M	10
Single heated wire system with 1m limb	2.4m	22HW2422M	10
Single heated wire system with 1m limb	3.1m	22HW3122M	10
Single heated with 1m limb, auto-fill humidification chamber	1.6m	22HWC1622M	10
Single heated with 1m limb, auto-fill humidification chamber	2.4m	22HWC2422M	10
Single heated with 1m limb, auto-fill humidification chamber	3.1m	22HWC3122M	10
Paediatric single heated wire system	1.6m	22HW1615M	10
<b>Dual heated water trap systems</b>			
Dual heated wire system 1m limb	1.6m	22HW21622FF10M	10
Dual heated wire system 1m limb	1.6m (Universal)	22HW21622FF10MU	10
Dual heated ventilator system	1.6m	22HW162202	10
Neonatal heated system	1.6m	22HWT161001	10
Heated ventilator system with water trap	1.6m	22HWT16220110	10
Heated wire system standard corrugated	1.6m	22PHW1610FF	10
Heated wire system (smoothbore)	1.6m	22SBHW161508	10
Dual heated wire system, 0.5m (smoothbore) limb	1.6m	22SBHW1622MM	10
Heated ventilator system, 15mm	1.8m	22HW181501	10
Heated ventilator system, 22mm	1.8m	22HW182201	10
<b>Critical care accessories</b>			
Adult heater chamber with entrainment system	2202CHADKIT		1
Paediatric heater chamber with entrainment system	2202CHPDKIT		1
Special T nebuliser kit	22157299V		10

Accessories for critical care.  
Volume ventilator systems.

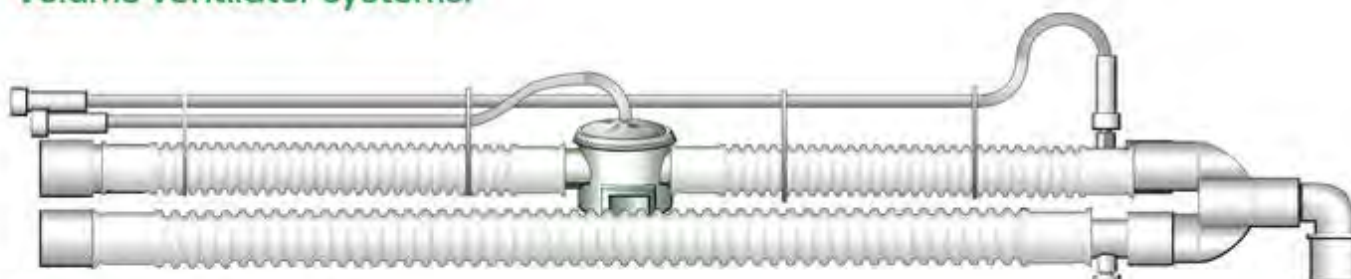

Volume ventilator system: 223280

PRODUCT	CODE	UNITS
---------	------	-------

Volume ventilator circuit accessories

Respiratory care system 3-in-1 kit	22P1622CP3-1	10
Neonatal system	22N161022F	1
Volume ventilator system	223280	10



CPAP masks

CPAP mask LARGE	22CP004	10
CPAP mask MEDIUM	22CP003	10
CPAP mask SMALL	22CP002	10

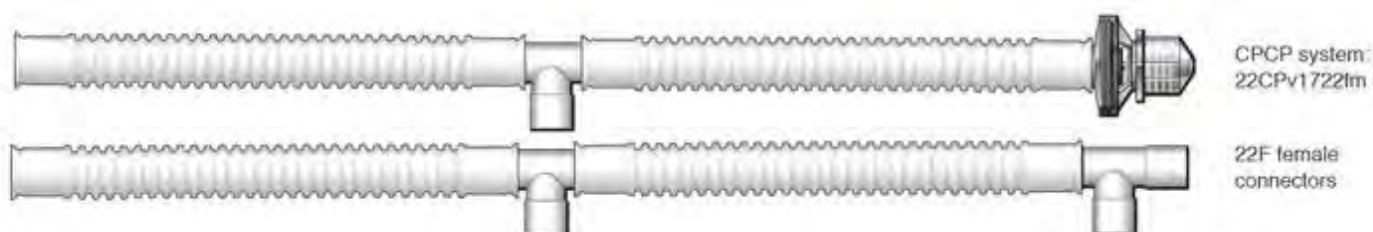

CPAP systems

1.75m, Peep Valve, T-piece 22m/15F connectors	22CPV1722FM	20
1.75m, No valve, T-piece 22m/15F connectors	22CP1722FF	20
2.4m, T piece(2) 22m/15F connectors	22CPT2422FF	20
Peep valve 0-20cm (fitting 22OD x 15ID) Single use	2250-0099	20
Peep valve 0-20cm (fitting 22OD x 15ID) Reusable	22RE-0099	20
Peep valve 0-20cm (fitting 30ID) Single use	2250-0093	20
Peep valve 0-20cm (fitting 30ID) Reusable	22RE-0093	20



## Entonox systems

Meditech offer a wide variety of entonox systems to provide the right product options for our customers. If our standard products do not cover your requirement; we offer a custom design service.

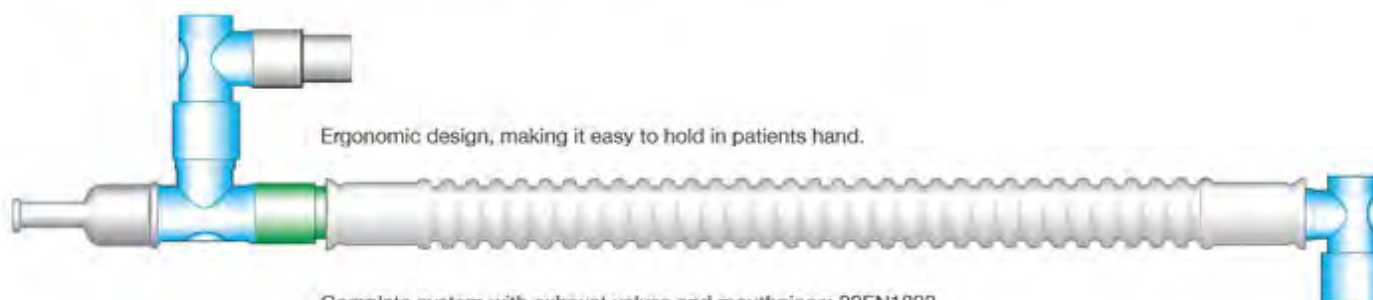

Ergonomic design, making it easy to hold in patients hand.

Complete system with exhaust valves and mouthpiece: 22EN1822



Available in pink tubing, blue tubing and white tubing options.

Complete system with exhaust valves and X-Tendible™ tubing 22ENTX282228

PRODUCT	CODE	UNITS
---------	------	-------

## Entonox systems

1.8m with valves and mouthpiece	22EN1822	10
2.4m with valves and mouthpiece	22EN2422	10
1.8m with valves and mouthpiece	22SBHW1822MM	10
X-Tendible™ 2.8m with scavenging tubing	22ENTX282228	50
Bacterial/Viral filter & mouthpiece	22EN2832	20

Meditech's X-Tendible™ tubing is a great space saver

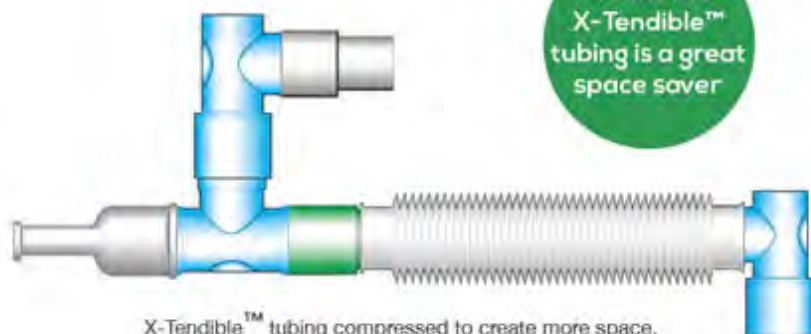

X-Tendible™ tubing compressed to create more space.



Filter and mouthpiece for use with reusable demand valve. The filter protects the patient and valve from contamination.

## Multi-mask interchangeable system

Compatible for all treatments by adding accessories. One mask per patient change. Change treatment, change accessory. An Interchangeable system.

How the Multi-mask interchangeable system works. various options available.

### 1 Mouthpiece connectors.

Various T-piece connectors for different configurations. All interchangeable to fit masks at No.2.

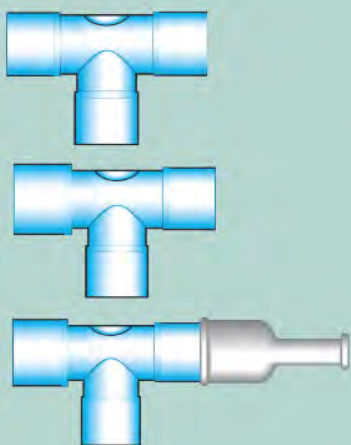

### 2 Oxygen face masks.

Oxygen face masks connect to T-piece and venturi jets on no.3.



### 3 Venturi Jets

These fit directly to mask options (2) and the oxygen spigot (4) and oxygen tubing (5) Different venturi jets are available. Making up the interchangeable system with different configurations.

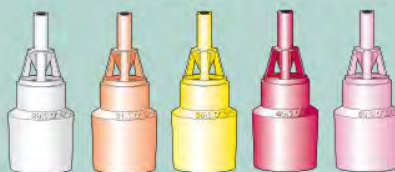

### 4 Oxygen spigot

22 outside diameter and 15 inside diameter. This fits to the venturi options illustrated above. Making up the interchangeable system with different configurations.

### 6 Various tubing options

MEDI FLEX™ standard tubing. Smoothbore tubing. X-Tendible™ tubing. Tubing to attach to a nebuliser chamber all sizes of connections available.

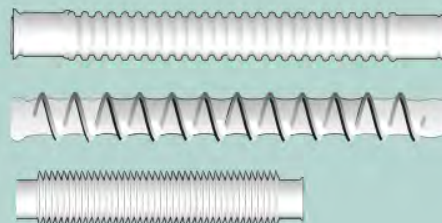

### 5 Oxygen tubing.

Fits to the oxygen spigot

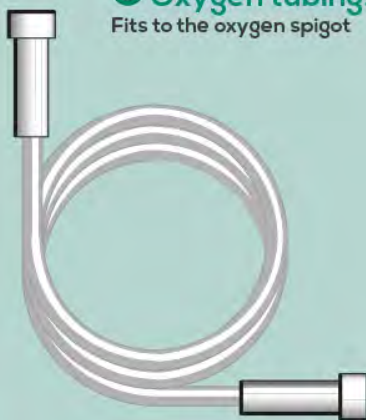

### 7 Nebuliser chamber

Drug nebuliser chamber all sizes of connection. All tubing options connect to the chamber.



### 8 MEDIMIST™

Universal fit nebuliser head. Oxygen delivered with aerosol therapy 28%-100% humidification.





## Venturi Jets and dilution kits



PRODUCT	FIT	COLOUR	CODE	UNITS
---------	-----	--------	------	-------

## Venturi jet kits and deluxe kits

Venturi mask kit (6 jets)	ADULT		222610	50
Venturi mask kit (6 jets)	PAEDIATRIC		222620	50
Venturi mask kit (adjustable)	ADULT		224450	50
Venturi mask kit (adjustable)	PAEDIATRIC		222650	50
Venturi mask kit (adjustable high flow)	ADULT		224451	50
Deluxe adjustable venturi mask kit	ADULT		2244501	50
Deluxe adjustable venturi mask kit	PAEDIATRIC		222651	50

## Venturi mask direct fittings

Venturi mask with direct fit venturi 24%	ADULT	blue	●	22142624	50
Venturi mask with direct fit venturi 28%	ADULT	white	○	22142628	50
Venturi mask with direct fit venturi 31%	ADULT	orange	●	22142631	50
Venturi mask with direct fit venturi 35%	ADULT	yellow	●	22142635	50
Venturi mask with direct fit venturi 40%	ADULT	red	●	22142640	50
Venturi mask with direct fit venturi 50%	ADULT	pink	●	22142650	50
Venturi mask with direct fit venturi 60%	ADULT	green	●	22142660	50
Venturi mask with direct fit venturi 24%	PAEDIATRIC	blue	●	22147624	50
Venturi mask with direct fit venturi 28%	PAEDIATRIC	white	○	22147628	50
Venturi mask with direct fit venturi 31%	PAEDIATRIC	orange	●	22147631	50
Venturi mask with direct fit venturi 35%	PAEDIATRIC	yellow	●	22147635	50
Venturi mask with direct fit venturi 40%	PAEDIATRIC	red	●	22147640	50
Venturi mask with direct fit venturi 50%	PAEDIATRIC	pink	●	22147650	50
Venturi mask with direct fit venturi 60%	PAEDIATRIC	green	●	22147660	50

## Venturi jets

Venturi diluter jet (fixed O <sub>2</sub> %) 24%		blue	●	221024	100
Venturi diluter jet (fixed O <sub>2</sub> %) 28%		white	○	221028	100
Venturi diluter jet (fixed O <sub>2</sub> %) 31%		orange	●	221031	100
Venturi diluter jet (fixed O <sub>2</sub> %) 35%		yellow	●	221035	100
Venturi diluter jet (fixed O <sub>2</sub> %) 40%		red	●	221040	100
Venturi diluter jet (fixed O <sub>2</sub> %) 50%		pink	●	221050	100
Venturi diluter jet (fixed O <sub>2</sub> %) 60%		green	●	221060	100

We have a full range of CO<sub>2</sub> Products on p28

PRODUCT	FIT	CODE	UNITS
---------	-----	------	-------

**Nasal cannulae**

Nasal cannula with curved flared tips	ADULT	221585	50
Nasal cannula with curved soft tips	ADULT	221583S	50
Nasal cannula with straight tips	ADULT	221582	50
Nasal cannula	CHILD	221601	50
Nasal cannula	INFANT	221602	50

**Oxygen tubing**

Oxygen tubing with connectors	1.8m	221103	100
Oxygen tubing with connectors	2.1m	221174	100
Oxygen tubing with connectors	3.0m	221103PMH	100
Oxygen tubing with connectors	4.0m	221175	50



221602



221585



221583S

**Various tubing options**

MEDIFLEX™ standard tubing.  
Smoothbore tubing.  
X-Tendible™ tubing.  
Tubing to attach to a nebuliser chamber  
all sizes of connections available.

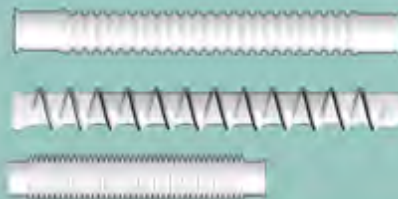

PRODUCT	LENGTH	CUFF	CODE	UNITS
---------	--------	------	------	-------

**Corrugated tubing**

Corrugated aerosol tubing 22mm	50m roll	450mm	225022450	1
Corrugated aerosol tubing 22mm	50m roll	150mm	225022150	1
Corrugated aerosol tubing 22mm	50m roll	100mm	225022100	1
Corrugated aerosol tubing 22mm	1.6m cut	No cuff	221622	50
Corrugated aerosol tubing 22mm	1.8m cut	No cuff	221822	50
Corrugated aerosol tubing 15mm	50m roll	450mm	225015450	1
Corrugated aerosol tubing 15mm	50m roll	150mm	2250151501	1

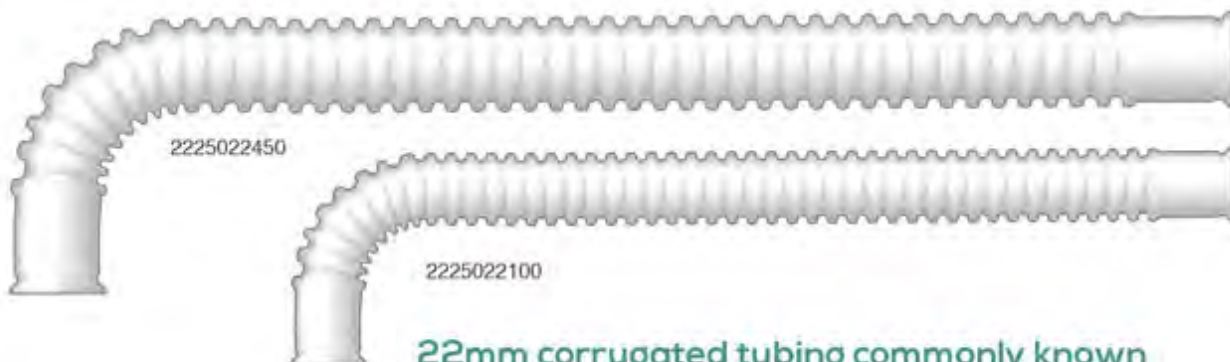

22mm corrugated tubing commonly known as elephant tubing and scavenging tubing.



### Oxygen non PVC ECO masks



### Hi- concentration mask with tubing

221425



### Oxygen masks



PRODUCT	FIT	CODE	UNITS
---------	-----	------	-------

#### Oxygen masks

Oxygen mask	ADULT	221420	50
Oxygen mask	PAEDIATRIC	221470	50
Oxygen mask short style	ADULT	221430	50
Oxygen mask	INFANT	221480	50
Hi-concentration mask non-rebreathing	ADULT	2214230	50
Hi-concentration mask non-rebreathing w/tubing	ADULT	221425	50
Oxygen non PVC ECO mask	ADULT	221420ECO	50

#### Aerosol masks

Aerosol mask	ADULT	221426	50
Aerosol mask	PAEDIATRIC	221476	50
Aerosol mask	INFANT	221479	50
Aerosol mask face tent	ADULT	221490	50
Aerosol mask tracheotomy	ADULT	222400	50
Aerosol mask tracheotomy	PAEDIATRIC	222470	50
Aerosol mask non PVC (ECO)	ADULT	221426ECO	50

## CO2 Range

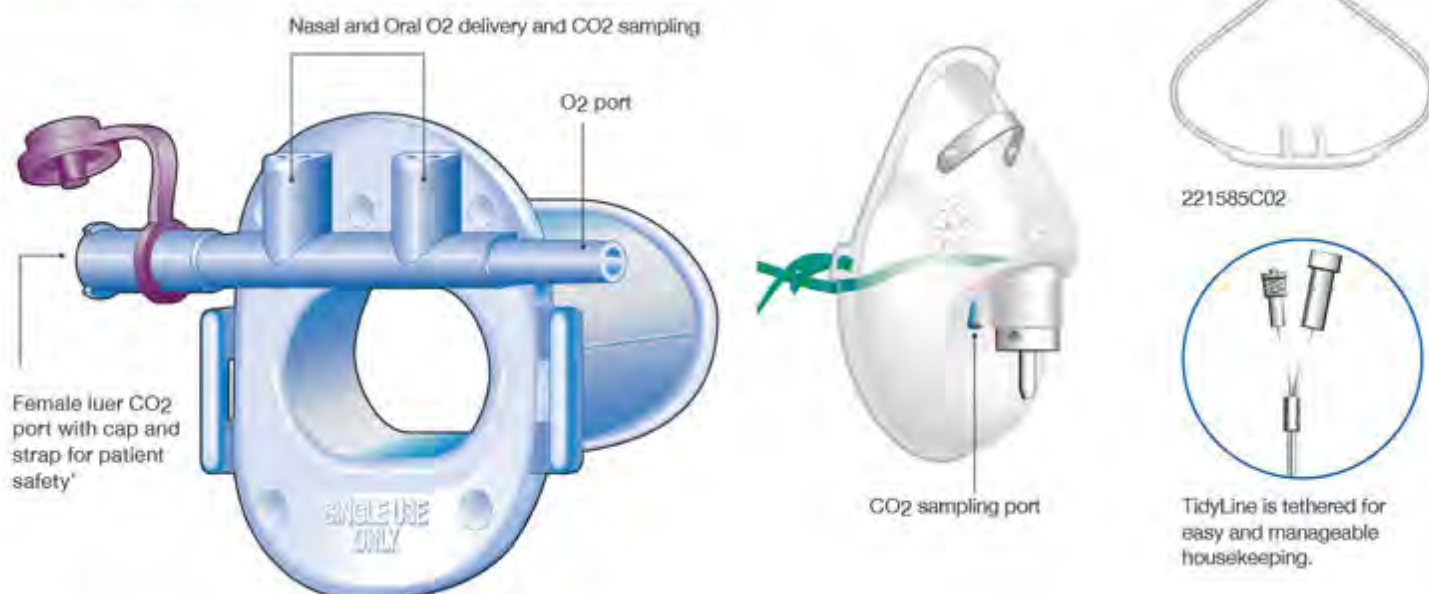

## CAPNOGUARD<sup>®</sup> Bite Block

Meditech's Capnoguard bite block solves the need for the recommended CO2 monitoring of patients during endoscopic procedures.

Capnography (CO2 monitoring) has now become a recognised standard in procedures involving intubated patients. It is widely used across other clinical areas such as in emergency departments, theatre recovery (post op) and endoscopy to provide CO2 monitoring and oxygen delivery. In the endoscopy department a number of accessories such as nasal cannula are required with a standard bite block in order to deliver oxygen and monitor CO2. With the CAPNOGUARD we have incorporated both options into the one device, which offers a cost effective solution. In addition the CAPNOGUARD incorporates a soft silicone teeth guard.

PRODUCT	CODE	UNITS
---------	------	-------

### Capnoguard bite block and accessories

Capnoguard: endoscopy standard with strap	22881100	20
Capnoguard: endoscopy with CO2/O2 ports & teeth guard	22881102	20
Capnoguard: endoscopy with CO2/O2 ports/strap/teeth guard	22881102S	20
Micron filter 0.45 luer lock fitting	2283230	100
Elastic strap - latex free	228811SS	100

### CO2 Product range

Paediatric CO2 oxygen mask with CO2 sampling port	22147CO2	50
Paediatric CO2 mask with 3M Tidyline O2/CO2	221471CO2	50
Adult oxygen mask CO2 sampling port	22142CO2	50
Adult capnography mask with 3M Tidyline O2/CO2	221421CO2	50
Adult CO2 nasal cannula with 3M Tidyline O2/CO2	221585CO2	50
Paediatric CO2 nasal cannula - 3M Tidyline O2/CO2	221601CO2	50
3M Tidyline O2/CO2 Oxygen tubing	2211030CO2	50



## Nebuliser kits and accessories

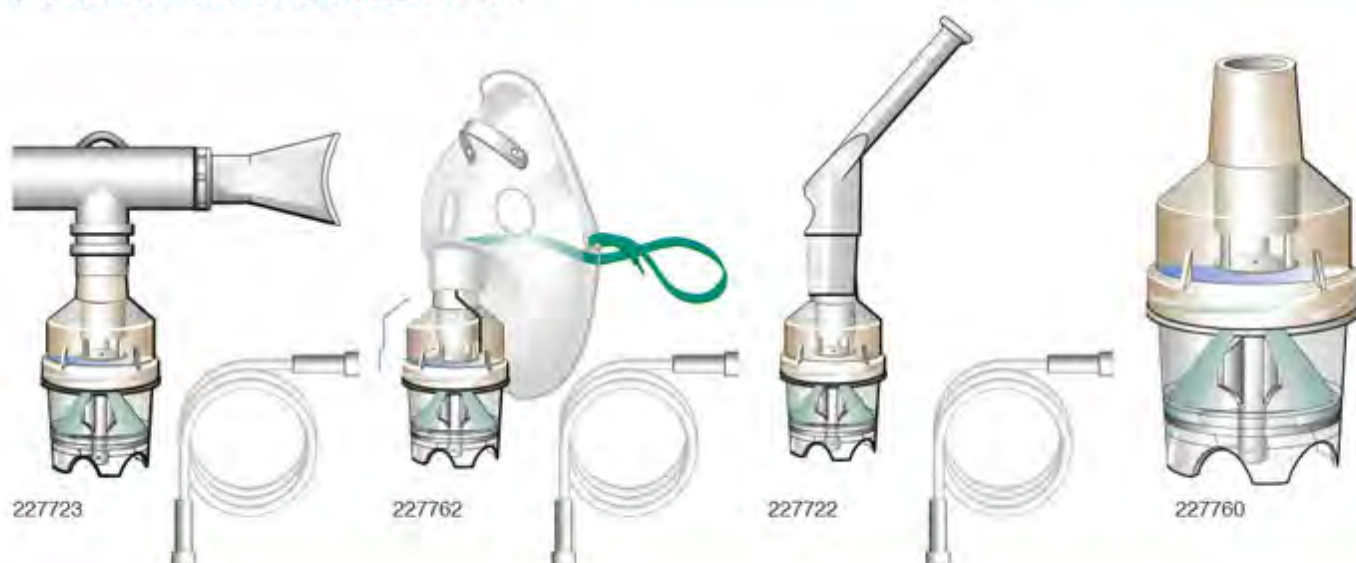

PRODUCT	CODE	UNITS
---------	------	-------

### MEDI MIST™ nebulisers and humidifiers

MEDI MIST nebuliser	227760	100
MEDI MIST nebuliser with adult mask & tubing	227762	50
MEDI MIST nebuliser with paediatric mask & tubing	227772	50
MEDI MIST nebuliser with angled mouthpiece & tubing	227722	50
MEDI MIST nebuliser with T-piece mouthpiece & tubing	227723	50
MEDI MIST nebuliser with one-way valves systems	22771575	25
MEDI MIST nebuliser In-line system for adult systems	22776622	25
MEDI MIST nebuliser In-line system for paediatric systems	22776615	25
MEDI MIST nebuliser In-line system for neonate systems	22776610	25
MEDI MIST nebuliser In-line system for neonate bagging	22776605L	10
Nebuliser jar refillable 35% - 100% oxygen	222305	24
Humidifier jar refillable bubble through style	222302	24
Nebuliser head 28% - 100% oxygen	22228	50
BOC adaptor to connect above items to flow meter	22810158	100
Flow meter adaptor nipple	22810159	100



222028



222302



222305



22810159



22810158

## Manual resuscitation kits

2250-0012

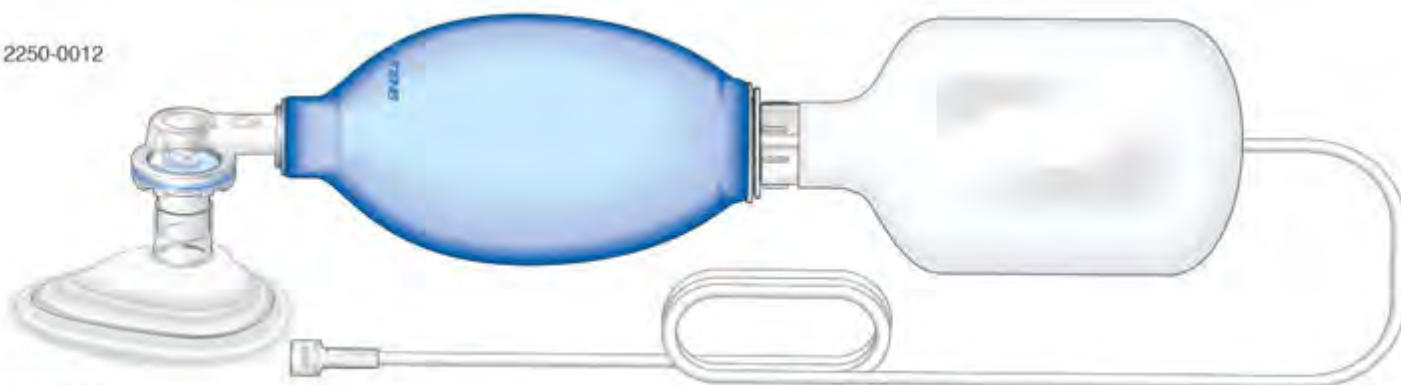

2250-0012

PRODUCT	CODE	UNITS
---------	------	-------

## Manual resuscitation kits

Adult kit, with mask, reservoir bag and tubing	2250-0012	6
Child kit, with mask, reservoir bag and tubing	2250-0021	6
Infant kit, with mask, reservoir bag and tubing	2250-0031	6
Pocket resuscitation mask	2250-CPR	10

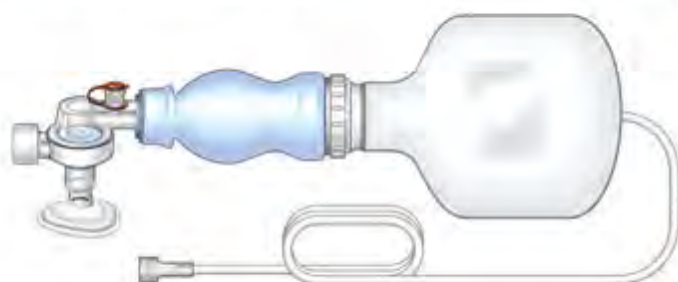

Infant 2250-0031

Child 2250-0021

Pocket resuscitation mask.  
Comes with durable and protective case, 2250-CPR.



PRODUCT	SINGLE USE CODE	COLOUR	SIZE	UNITS
---------	-----------------	--------	------	-------

## Nasopharyngeal

Nasopharyngeal	22507514B	②	Blue ●	3.0mm ID, 14Fr	10
Nasopharyngeal	22507516B	②	Blue ●	3.5mm ID, 16Fr	10
Nasopharyngeal	22507518B	②	Blue ●	4.0mm ID, 18Fr	10
Nasopharyngeal	22507520B	②	Blue ●	4.5mm ID, 20Fr	10
Nasopharyngeal	22507522B	②	Blue ●	5.0mm ID, 22Fr	10
Nasopharyngeal	22507524B	②	Blue ●	5.5mm ID, 24Fr	10
Nasopharyngeal	22507526B	②	Blue ●	6.0mm ID, 26Fr	10
Nasopharyngeal	22507528B	②	Blue ●	6.5mm ID, 28Fr	10
Nasopharyngeal	22507530B	②	Blue ●	7.0mm ID, 30Fr	10
Nasopharyngeal	22507532B	②	Blue ●	7.5mm ID, 32Fr	10
Nasopharyngeal	22507534B	②	Blue ●	8.0mm ID, 34Fr	10
Nasopharyngeal	22507536B	②	Blue ●	8.0mm ID, 36Fr	10
Nasopharyngeal	22507536B	②	Blue ●	8.0mm ID, 38Fr	10



## Guedels



PRODUCT	CODE	STERILE	COLOUR	SIZE	UNITS
---------	------	---------	--------	------	-------

### Guedal airways

Colour coded integral bite block providing a safer option.

Adult guedel	221005	SU221005	②	Yellow		5	100
Adult guedel	221004	SU221004	③	Pink		4	100
Adult guedel	221003	SU221003	④	Orange		3	100
Child guedel	221002	SU221002	⑤	Green		2	100
Child guedel	221001	SU221001	⑥	White		1	100
Poediatric guedel	221000	SU221000	⑦	Black		0	100
Poediatric guedel	221010	SU221010	⑧	Blue		00	100
Neonate guedel	221011	SU221011	⑨	Clear		000	100

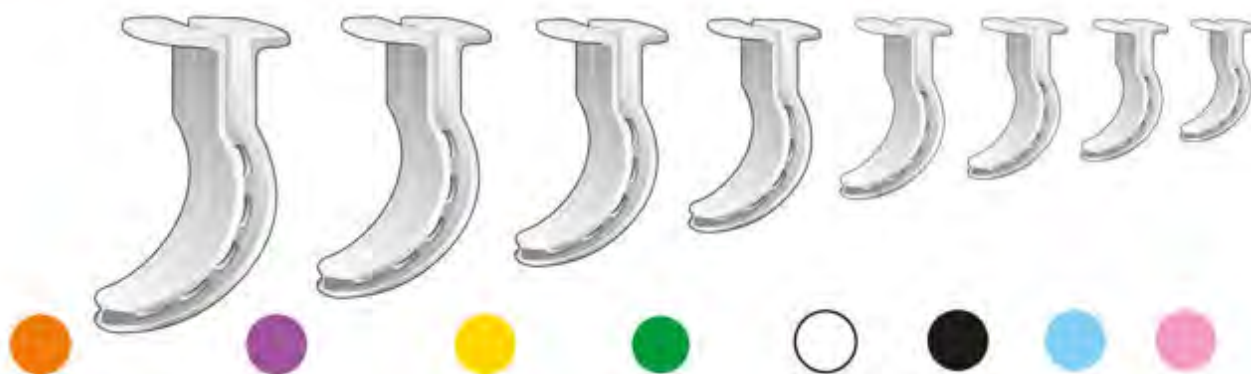

PRODUCT	CODE	LENGTH	COLOUR	SIZE	UNITS
---------	------	--------	--------	------	-------

### Berman airways Colour coded

Berman airway	22BM040	40mm	Pink		000	100
Berman airway	22BM050	50mm	Light Blue		00	100
Berman airway	22BM060	60mm	Black		0	100
Berman airway	22BM070	70mm	White		1	100
Berman airway	22BM080	80mm	Green		2	100
Berman airway	22BM090	90mm	Yellow		3	100
Berman airway	22BM0100	100mm	Purple		4	100
Berman airway	22BM0110	110mm	Orange		5	100

Intubating Bermans available please contact us [sales@meditechsystems.co.uk](mailto:sales@meditechsystems.co.uk)



# medi tech

systems limited

Supporting every breath

Meditech Systems Limited.  
Shrublands Estate,  
Sherstock, Shaftesbury,  
Dorset, SP7 9PT.  
tel: +44 (0)1747 821546  
email: sales@meditechsystems.co.uk

Meditech Systems Asia Pacific Pty Limited.  
Unit 3 29 May Holman Drive,  
Bassendean,  
WA 6054 Australia.  
tel: +61 (0)8 6162 9911  
email: admin@meditechsystems.com.au

Visit us: [www.meditechsystems.co.uk](http://www.meditechsystems.co.uk)

📘 facebook: meditechsystemslimited 🐦 twitter: @MeditechLtd

